



## 6.5" WVGA Touch Screen Monitor

# TME-S370

- **OWNER'S MANUAL**  
Please read before using this equipment.
- **MODE D'EMPLOI**  
Veuillez lire avant d'utiliser cet appareil.
- **MANUAL DE OPERACIÓN**  
Lealo antes de utilizar equipe.

---

**ALPINE ELECTRONICS MARKETING, INC.**

1-1-8 Nishi Gotanda  
Shinagawa-ku  
Tokyo 141-0031, Japan  
Phone 03-5496-8231

**ALPINE ELECTRONICS OF AMERICA, INC.**

19145 Gramercy Place  
Torrance, California 90501 U.S.A.  
Phone 1-800-ALPINE-1 (1-800-257-4631)

**ALPINE ELECTRONICS OF CANADA, INC.**

777 Supertest Road  
Toronto, Ontario M3J 2M9 Canada  
Phone 1-800-ALPINE-1 (1-800-257-4631)

**ALPINE ELECTRONICS OF AUSTRALIA PTY, LTD.**

161-165 Princess Highway, Hallam  
Victoria 3803, Australia  
Phone 03-8787-1200

**ALPINE ELECTRONICS (EUROPE) GmbH**

Wilhelm-Wagenfeld-Str. 1-3  
80807 Munich, Germany  
Phone 089-32 42 640

**ALPINE ELECTRONICS OF U.K., LTD.**

ALPINE House  
Fletchamstead Highway, Coventry CV4 9TW,  
U.K.  
Phone 0870-33 33 763

**ALPINE ELECTRONICS (BENELUX) GmbH**

Leuvensesteenweg 510-B6,  
1930 Zaventem, Belgium  
Tel.: 02-725 1315

**ALPINE ELECTRONICS FRANCE S.A.R.L.**

(RCS PONTOISE B 338 101 280)  
98, Rue de la Belle Etoile, Z.I. paris Nord II,  
B.P. 50016, 95945 Roissy Charles de Gaulle  
Cedex, France  
Phone 01-48638989

**ALPINE ITALIA S.p.A.**

Viale C. Colombo 8, 20090 Trezzano  
Sul Naviglio (MI), Italy  
Phone 02-484781

**ALPINE ELECTRONICS DE ESPAÑA, S.A.**

Portal de Gamarra 36, Pabellón, 32  
01013 Vitoria (Alava)-APDO 133, Spain  
Phone 945-283588

## **IMPORTANT**

Please record the serial number of your unit in the space provided below and keep it as a permanent record. The serial number plate is located on the bottom of the unit.

SERIAL NUMBER: \_\_\_\_\_

INSTALLATION DATE: \_\_\_\_\_

INSTALLATION TECHNICIAN: \_\_\_\_\_

PLACE OF PURCHASE: \_\_\_\_\_

# Contents

## Operating Instructions

### WARNING

<b>Warning</b> .....	<b>2</b>
<b>Caution</b> .....	<b>2</b>
<b>Precautions</b> .....	<b>3</b>

### Getting Started

Location of Controls.....	4
Turning Power On and Off .....	4
Adjusting the Volume and Mute.....	4
Switching the Source.....	5

### Auxiliary Device Operation

DVD Video Player Operation (Optional) .....	6
iPod Operation (Optional) .....	7
DVD-HU Operation (Optional) .....	7
DVB-T Operation (Optional Europe Only).....	8
Menu Control Screen.....	8
TV Operation (Optional).....	9
Sirius TV Operation (Optional).....	9
Display Mode .....	10

### Setup

General Setups.....	11
System Setup Operations.....	11
AUX Setup Operations .....	12
Navigation Setup Operations.....	13
Camera Setup Operations.....	13
Display Setups .....	14
Reset Display Setting.....	15

### Information

In Case of Difficulty .....	15
Specifications .....	17
Accessories .....	17

## Installation and Connections

<b>Warning</b> .....	<b>18</b>
<b>Caution</b> .....	<b>18</b>
<b>Precautions</b> .....	<b>19</b>
Mounting Options .....	19
Connections.....	20
Lock-out Function.....	21

---

---

# Operating Instructions

---

## WARNING



### WARNING

**This symbol means important instructions. Failure to heed them can result in serious injury or death.**

---

#### **INSTALL THE PRODUCT CORRECTLY SO THAT THE DRIVER CANNOT WATCH TV/VIDEO UNLESS THE VEHICLE IS STOPPED AND THE EMERGENCY BRAKE IS APPLIED.**

It is dangerous (and illegal in many states) for the driver to watch TV/Video while driving a vehicle. Installing this product incorrectly enables the driver to watch TV/Video while driving. This may cause a distraction, preventing the driver from looking ahead, thus causing an accident. The driver or other people could be severely injured.

---

#### **DO NOT WATCH VIDEO WHILE DRIVING.**

Watching video may distract the driver from looking ahead of the vehicle and cause an accident.

---

#### **DO NOT OPERATE ANY FUNCTION THAT TAKES YOUR ATTENTION AWAY FROM SAFELY DRIVING YOUR VEHICLE.**

Any function that requires your prolonged attention should only be performed after coming to a complete stop. Always stop the vehicle in a safe location before performing these functions. Failure to do so may result in an accident.

---

#### **KEEP THE VOLUME AT A LEVEL WHERE YOU CAN STILL HEAR OUTSIDE NOISES WHILE DRIVING.**

Excessive volume levels that obscure sounds such as emergency vehicle sirens or road warning signals (train crossings, etc.) can be dangerous and may result in an accident. LISTENING AT LOUD VOLUME LEVELS IN A CAR MAY ALSO CAUSE HEARING DAMAGE.

---

#### **MINIMIZE DISPLAY VIEWING WHILE DRIVING.**

Viewing the display may distract the driver from looking ahead of the vehicle and cause an accident.

---

#### **DO NOT DISASSEMBLE OR ALTER.**

Doing so may result in an accident, fire or electric shock.

---

#### **USE ONLY IN CARS WITH A 12 VOLT NEGATIVE GROUND.**

(Check with your dealer if you are not sure.) Failure to do so may result in fire, etc.

---

#### **KEEP SMALL OBJECTS SUCH AS BATTERIES OUT OF THE REACH OF CHILDREN.**

Swallowing them may result in serious injury. If swallowed, consult a physician immediately.

---

#### **USE THE CORRECT AMPERE RATING WHEN REPLACING FUSES.**

Failure to do so may result in fire or electric shock.

---

#### **USE THIS PRODUCT FOR MOBILE 12V APPLICATIONS.**

Use for other than its designed application may result in fire, electric shock or other injury.

---

#### **DO NOT INSTALL THE MONITOR NEAR THE PASSENGER SEAT AIR BAG.**

If the unit is not installed correctly, the air bag may not function correctly and may cause an accident and injuries.



### CAUTION

**This symbol means important instructions. Failure to heed them can result in injury or material property damage.**

---

#### **HALT USE IMMEDIATELY IF A PROBLEM APPEARS.**

Failure to do so may cause personal injury or damage to the product. Return it to your authorized Alpine dealer or the nearest Alpine Service Center for repairing.



# PRECAUTIONS

---

## Product Cleaning

Use a soft dry cloth for periodic cleaning of the product. For more severe stains, please dampen the cloth with water only. Anything else has the chance of dissolving the paint or damaging the plastic.

---

## Temperature

Be sure the temperature inside the vehicle is between +45°C (+113°F) and 0°C (+32°F) before turning your unit on.

---

## Maintenance

If you have problems, do not attempt to repair the unit yourself. Return it to your Alpine dealer or the nearest Alpine Service Station for servicing.

---

## Installation Location

Make sure the TME-S370 will not be installed in a location subjected to:

- Direct sun and heat
  - High humidity and water
  - Excessive dust
  - Excessive vibrations
- 
- After turning the system off, a slight ghost of the image will remain temporarily. This is an effect peculiar to LCD technology and is normal.
  - In cold temperature conditions, the screen may lose contrast temporarily. After a short warm-up period, it will return to normal.
- 

Operation of some of the functions of this unit is very complex. Because of this, it was deemed necessary to place these functions into a special screen. This will restrict operation of these functions to times when the vehicle is parked. This ensures the focus of the driver's attention will be on the road and not on the TME-S370.

This has been done for the safety of the driver and passengers. The setup operation cannot be made if the car is moving. The car must be parked and the parking brake must be engaged for the procedure described in the Owner's Manual to be valid. The warning "Operation is not allowed while driving," will be displayed if any attempts are made to perform these operations while driving.

---

# Getting Started

## Location of Controls

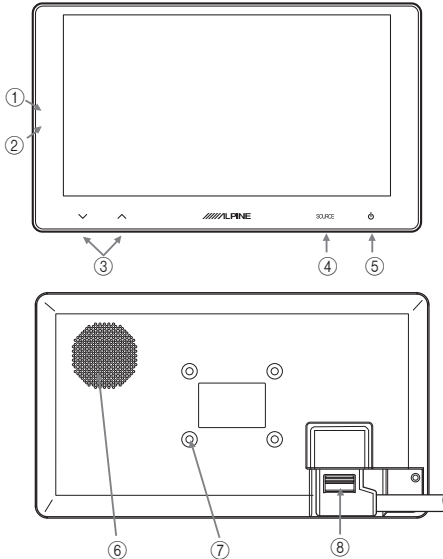

- ① **Remote IR Receiver**  
The IR receiver receives the remote IR command from the remote controller of connected devices.
- ② **Ambient Light Sensor**  
Changes the LCD backlight and the soft-touch key backlight automatically, when the surrounding brightness changes.
- ③ **Volume Buttons**  
Adjust the volume level by pressing the  $\wedge$  or  $\vee$  buttons. AUX and Navigation independently controls volume.  
-For details, refer page 12.
- ④ **SOURCE Button**  
Returns to Source Select screen.
- ⑤ **(POWER)/Mute**  
Turns the monitor power On and Off.  
The monitor power turns Off when press and hold the power button for 2 seconds. Power button changes to red in standby mode.  
Turns Mute on when press the power button, when the unit is turned on.  
The mute icon appears on the screen.

- ⑥ **Built-in Speaker**  
Outputs sound for AUX and Navigation guidance.
- ⑦ **AMPS Mounting Hole**  
Universal AMPS accessory is available in any third party dealer.
- ⑧ **Locking Connector to the hideaway box**  
Connects to the hideaway box.  
Make sure to lock properly.

## Turning Power On and Off

- 1 Press **POWER** to turn on the unit.
- 2 Press and hold **POWER** for 2 seconds to turn off the unit.

- Some operations cannot be performed while the vehicle is in motion. In order to operate, enable lock-out function. See page 21 for details.

## Adjusting the Volume and Mute

- 1 Adjust the volume level by pressing  $\wedge$  or  $\vee$ .  
Turn the volume up to turn Off mute.
- If “Changing Sound Output (HU Vol. Control)” (page 12) is set to on, you can adjust HU speaker volume.
  - The volume control bar disappears after 3 seconds once the volume operation is completed.
  - The volume bar does not indicate when the HU volume control mode is on.

## Switching the Source

### 1 Touch the desired source on Source Select screen.

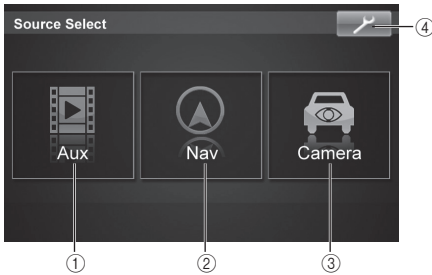

### 1 AUX

The AUX Input screen is displayed.

- The name given as the source name in “Source Name” under AUX Setup Operation on page 12 is displayed.
- Refer to the section titled “Auxiliary Device Operation” on page 6 for details.

### 2 Nav (Navigation)

The Navigation screen is displayed.

- For navigation operation, refer to the Owner's Manual for the navigation system.
- Refer to page 13 for Navigation Setup Operation.

### 3 Rearview Camera

Camera input is displayed, when the car is in reverse gear OR the rearview camera is selected on Source Select screen.

- For operation, refer to the Owner's Manual for the rearview camera.
- Refer to page 13 for Camera Setup Operation.
- To enable to use reverse wire, camera interrupt must be on reverse. See page 13 for detail.

### 4 SETUP

The System Setup screen is displayed.



- For details, refer to “Setup” (page 11).

# Auxiliary Device Operation

If an ALPINE device is connected to AUX, the device is controllable from the unit. This section explains how to operate representative devices.

This operation cannot be performed while the vehicle is in motion. In order to display AUX input, enable lock-out function. See page 21 for details.

## DVD Video Player Operation (Optional)

Operable when optional Alpine DVD Player/DVD Changer is connected.

When DVD is selected in “Source Name” under AUX Setup Operation (page 11), DVD is displayed in Source Select screen.

Refer to owner's manual of DVD video player for details.

### 1 Touch the display panel to display the operation control bar.

- The operation control bar changes to the visual screen in the DVD mode for 5 seconds after an operation has been performed. Touch the display panel to display the operation control bar again.

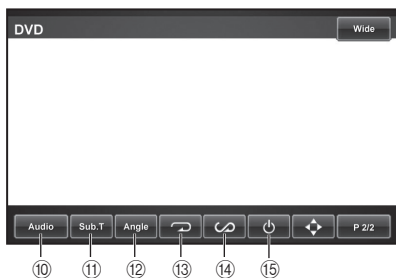
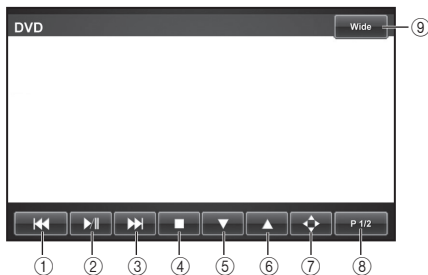

- Fast Reverse**  
Finds the beginning of track/chapter. Touching and holding plays fast-reverse.
- Play/Pause**  
Pauses and plays back.
- Fast Forward**  
Finds the beginning of a track/chapter. Touching and holding plays fast-forward.
- PRE- STOP/STOP**
- Switch DISC** (Alpine DVD Changer only)
- Switch DISC** (Alpine DVD Changer only)
- Menu Control**  
Displays the Menu Control screen. See page 8 for detail.
  - Press and hold function is for future product control.
- Page Change**  
Switches between page 1 and page 2 of operation control bar.
- Display Mode Setting**  
Wide/Cinema/Normal  
See page 10 for details.
- Audio**  
The sound switches between the alternate audio tracks recorded on the disc each time the button is pressed.
  - The selected alternate track becomes the default setting every time the power is turned on or the disc is replaced. If the disc does not include that track, the disc's default language is selected instead.
  - Not all discs will allow changing the alternate audio tracks during playback. In these cases, select audio tracks from the DVD's menu.
  - There may be a delay before the selected alternate track begins to play.
- Sub Title (Sub.T)**  
The Sub Title switches between the languages recorded on the disc and OFF each time the button is pressed.
  - There may be a delay before the selected subtitle appears.
  - Not all discs will allow changing the subtitles during playback. In these cases, select subtitles from the DVD's menu.



- *The selected subtitle language becomes the default setting every time the power is turned on or the disc is replaced. If the disc does not include that language, the disc's default language is selected instead.*
- *For some discs, the subtitles will be displayed even when this is set to off.*

**12 Angle**

The angle switches between the angles recorded on the disc, each time the button is pressed.

- *Some time may be required for the angle to change.*
- *Depending on the disc, the angle may switch in one of two ways.*
  - *Seamless* The angle switches smoothly.
  - *Non-seamless* When the angle is switched, a still picture is displayed first, after which the angle switches.

**13 Repeat**

Chapter/Track/Title Repeat Playback

**14 Shuffle**

Shuffles through audio tracks

**15 Power**

Turns the DVD Player/Changer on or off.

## iPod Operation (Optional)

The function is same as DVD Video Player operation. The function requires the iPod interface box, KCE-415i (USA/Europe model), KCE-425i (Europe model). See owner's manual for details.

Feature is limited depending on the iPod interface box.

## DVD-HU Operation (Optional)

Operable when optional Alpine DVD-HU is connected. When DVD-HU is selected in "Source Name" under AUX Setup Operation (page 12), DVD-HU is displayed in Source Select screen.

**1 Touch the display panel to display the operation control bar.**

- *The operation control bar changes to the visual screen in the DVD-HU mode for 5 seconds after an operation has been performed. Touch the display panel to display the operation control bar again.*

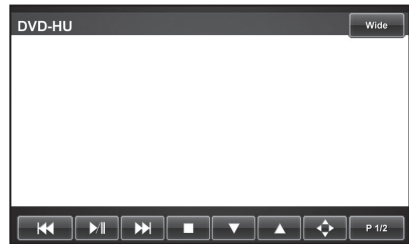

**1 Source**

Switches DVD-HU source (AM/FM radio, CD/DVD, etc.).

- *See page 6 for a description of additional button functions.*

## DVB-T Operation (Optional Europe Only)

Operable when optional Alpine DVB-T is connected. When DVB-T is selected in "Source Name" under AUX Setup Operation (page 12), the DVB-T is displayed in Source Select screen.

Refer to owner's manual of DVB-T for details.

### 1 Touch the display panel to display the operation control bar.

- The operation control bar changes to the visual screen in the DVB-T mode for 5 seconds after an operation has been performed. Touch the display panel to display the operation control bar again.

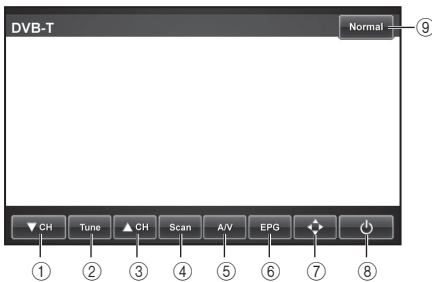

- ▼ CH**  
Decreases channels one by one.  
**▼ Fav**  
Decreases the preset numbers one by one.
- TUNE**  
Changes the tuning way (manual mode <CH> and preset number <Fav>).
- ▲ CH**  
Increases channels one by one.  
**▲ Fav**  
Increases the preset numbers one by one.
- Scan**  
This initiates the auto seek mode.
- A/V**  
Switches the input source of DVB-T tuner.
- EPG**  
Displays program guide.
- Directional Pad**  
Displays the Menu Control screen.
  - Press and hold function is for future product control.
- Power**  
Turns the DVB-T device ON/OFF.

### 9 Display Mode Setting

See Display Mode on page 10 for details.

## Menu Control Screen

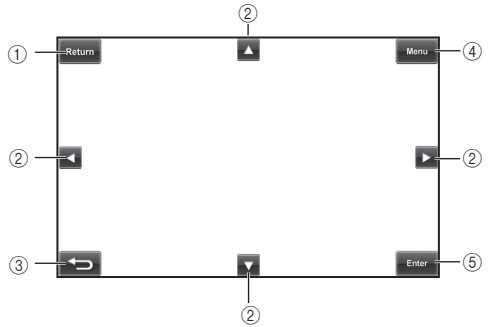

### 1 RETURN

Sends to return command to the source device.

### 2 ◀ ▶ ▲ ▼ ▶

This function is same as source remote control, up, down, right and left buttons.

### 3 ↶

Returns to the previous screen of monitor menu.

### 4 MENU

Sends the Menu command to the source device.

### 5 ENTER

Enters the selected item.

- Operation may differ depending on the connected device. Refer to owner's manual of the connected device.

## TV Operation (Optional)

Operable when optional Alpine Analog TV Tuner is connected. When TV is selected in "Source Name" under AUX Setup Operation (page 12), the TV is displayed in Source Select screen.

Refer to owner's manual of Alpine Analog TV Tuner.

- The operation control bar changes to the visual screen in the TV mode for 5 seconds after an operation has been performed. Touch the display panel to display the operation control bar again.



- ① **▼ CH**  
Decreases channels one by one.  
**▼ Fav**  
Decreases the preset numbers one by one.
- ② **TUNE**  
Changes the tuning way (manual mode <CH> and preset number <Fav>).
- ③ **▲ CH**  
Increases channels one by one.  
**▲ Fav**  
Increases the preset numbers one by one.
- ④ **Scan**  
This initiates the auto seek mode.
- ⑤ **Band**  
Changes the band (VHF/UHF).
- ⑥ **Display Mode Setting**  
See Display Mode on page 10 for details.
- ⑦ **Power**  
Turns the TV device ON/OFF.

## Sirius TV Operation (Optional)

Operable when optional Sirius Backseat TV is connected. When Sirius TV is selected in "Source Name" under AUX Setup Operation (page 12), Sirius TV is displayed in Source Select screen.

Refer to owner's manual of Sirius TV.

- The operation control bar changes to the visual screen in the Sirius TV mode for 5 seconds after an operation has been performed. Touch the display panel to display the operation control bar again.



- ① **▼ CH**  
Decreases channels one by one.
- ② **▲ CH**  
Increases channels one by one.
- ③ **Display Mode**  
See Display Mode on page 10 for details.
- ④ **Power**  
Turns the Sirius TV device ON/OFF.

## Display Mode

### *WIDE (Default Setting) / CINEMA / NORMAL*

**WIDE:** The monitor displays a normal picture wider to fit in a wide-screen monitor by evenly stretching out the picture horizontally.



**CINEMA:** The monitor displays a normal picture by stretching out the picture vertically. This mode is good for displaying a cinema type picture at the 16 : 9 ratio.



**NORMAL:** The monitor displays a normal picture at the centre of the screen with a vertical black band at each side.



# Setup

The operation cannot be performed while the vehicle is in motion. In order to operate the setup, enable lock-out function. See page 21 for details.

## General Setups

You can flexibly customize the unit to suit your own preferences and usage.

Use steps 1 through 4 to select one of the Setup modes to modify. See the applicable section below for details about the selected Setup item.

### 1 Touch [ ] on Source Select screen.

The System Setup screen is displayed.

### 2 Touch the desired setup item.

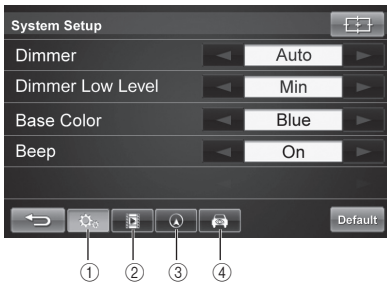

#### ① System Setup

Dimmer / Dimmer Low Level / Base Color / Beep.

#### ② Aux Setup

Source Name / TV System / Video Signal / HU Vol. Control.

#### ③ Navigation Setup

Nav Interrupt / Nav Interrupt Delay / Region

#### ④ Camera Setup

Camera Interrupt / Horizontal Flip / Vertical Flip

### 3 To change an item's setting(s) touch [ ◀ ] or [ ▶ ] for the desired item.

- When there are no more selections to view, the arrow turns gray.

### 4 Touch [ ] to exit setup menu.

## System Setup Operations



①



Touch this to screen alignment settings (See page 12).

②

#### Default

Touch this to restore settings to factory default settings.

Returns to the factory default settings of System setup. The message, "Restore default settings?" appears. Touch "Restore" to go back to the default settings.

- *Pressing and holding the Default button resets all settings including display setups. The message, "Restore all default settings?" appears. Press "Restore" to go back to the factory setting.*

## Setting the Brightness of the Backlighting (Dimmer)

### High / Low / Auto (Default Setting)

The illumination control adjusts the brightness of the backlighting based on the car ambient lighting for easier viewing.

**High:** Sets the strongest brightness of the screen.

**Low:** Sets the brightness of the screen to the same brightness that was set in Dimmer Low Level in "Adjusting the Minimum Level of Backlight (Dimmer Low Level)" (see instructions on page 12).

**Auto:** Adjusts the brightness of the background illumination of the monitor automatically to the brightness of the car interior.

## Adjusting the Minimum Level of Backlight (Dimmer Low Level)

### *Min (0) to Max (16) (Default Setting: Min)*

If Low is set in "Setting the Brightness of the Backlighting (Dimmer)" (page 11), you can adjust the brightness of the backlighting. This function can be used, for instance, to change the screen brightness while traveling at night.

## Changing the Base Color

### *Blue / Green / Red / Amber*

Select your favorite base color. The default color is blue. See navigation owner's manual to synchronize the base color of navigation system (NVE-M300 only). Check "Sync with Head Unit Color" under Display Setting.

## Beep Function

### *On (Default Setting) / Off*

**On:** Activates the beep when the button is pressed.

**Off:** Deactivates the beep. The beep will not be produced when a button on the unit is pressed.

## Adjusting the Touch Panel (Screen Alignment)

You must adjust the touch panel when the display position on the LCD and the touch position on the touch panel do not match.

### **1** Touch [ ].

The adjustment screen appears.

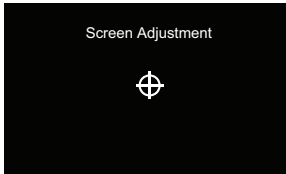

### **2** Press and hold the center of [ ] mark accurately and follow [ ] mark as appeared on the screen.

When the adjustment is completed, the Display Setup Mode screen is displayed.

## AUX Setup Operations

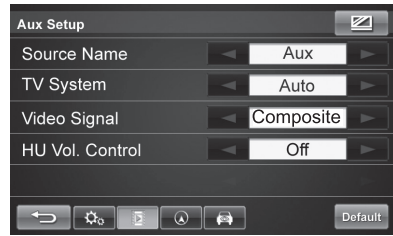

 Adjusts the AUX display setting. Refer to page 14 for details.

 Returns to the factory default settings of AUX setup. The message, "Restore default settings?" appears. Touch "Restore" to go back to the default settings.

## Source Name

### *Aux / DVD / DVD-HU / DVB-T / iPod / TV / Sirius TV*

Select the name from the following list, to be used for the product using the AUX input mode. This will apply to the button name on Source Select screen and the source name in title bar on AUX screen.

## Setting the TV System

### *Auto / NTSC / PAL*

The TV/Video system can be manually switched.

## Setting the Video Signal

### *Composite / S-Video*

The Video Signal selection menu is only available in AUX source. AUX must be connected with either Composite cable or S-Video cable. You cannot connect both cables at the same time. It may cause noise on the screen. Refer to System Connection (Page 20).

## Changing Sound Output (DVD-HU Vol. Control)



### *Off / On*

**Off:** Outputs sound through the built-in speakers. The volume indicator is displayed.

**On:** The built-in speaker is mute and head unit volume is adjustable from TME-S370 touch volume control. The volume indicator is not displayed. In order to control DVD-HU volume, make sure remote wire is connected to DVD head unit.

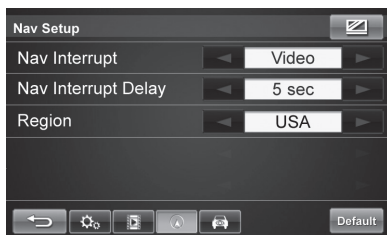
## Navigation Setup Operations



-  Adjusts the Navigation display setting. Refer to page 14 for details.
-  Returns to the factory default settings of Navigation setup. The message, "Restore default settings?" appears. Touch "Restore" to go back to the default settings.

### Setting Output of the Navigation Guidance Interpretation (Nav. Interrupt)

#### **Off / Voice / Video**

AUX operation cannot be performed while the vehicle is in motion.

When the navigation destination is set, the navigation interrupts the AUX screen that is currently displayed whenever navigation guidance is made.

- Off:** The navigation guidance will not interrupt the AUX screen and audio.
- Voice:** The navigation voice interrupts the AUX sound.
- Video:** The screen switches to the Navigation screen whenever navigation guidance is made.

### Setting Delay Timing of the Navigation Guidance Interruption (Nav Interrupt Delay)

#### **Off / 5 sec / 10 sec / 15 sec**

- Off:** The Navigation screen returns to the screen after guidance is complete.
- 5 sec:** The Navigation screen disappears 5 seconds after guidance is complete.
- 10 sec:** The Navigation screen disappears 10 seconds after guidance is complete.
- 15 sec:** The Navigation screen disappears 15 seconds after guidance is complete.



### Setting Region Manually

#### **USA / Europe**

You can switch the navigation region manually.

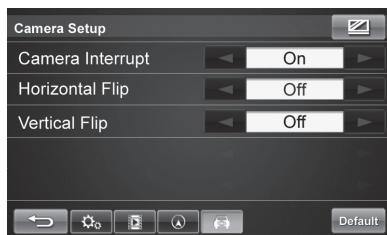
## Camera Setup Operations



-  Adjusts the Camera display setting. Refer to page 14 for details.
-  Returns to the factory default settings of Camera setup. The message, "Restore default settings?" appears. Touch "Restore" to go back to the default settings.

### Setting Output of the Rearview Camera Interruption

#### **Off / On**

- Off:** In this mode, the rearview does not appear on the screen whenever the vehicle is placed in reverse gear.
- On:** In this mode, the screen switches to rearview screen whenever the vehicle is placed in reverse gear.

### Flipping the Screen Horizontally

#### **Off / On**

This function allows you to see the rearview as a mirror image on the screen.

- Off:** The images on the screen appear normally.
- On:** The images on the screen appear mirrored.

### Flipping the Screen Vertically

#### **Off / On**

This function is useful if the camera is mounted upside down.

- Off:** The images on the screen appear normally.
- On:** The images on the screen appear upside down.

## Display Setups

It's easy to customize the unit to suit your preferences.

Use steps 1 to 4 below to select one of the SETUP modes to modify. See the applicable section below for details about the selected Setup item.

### 1 Touch [ ] on Source Select screen.

The Setup selection screen is displayed.

### 2 Select the desired setup screen.

### 3 Touch [ ] on the desired setup item.

## AUX Display Setup

*Brightness / Color / Tint / Contrast / Sharpness / Visual EQ*



## Navigation Display Setup

*Brightness / Contrast*

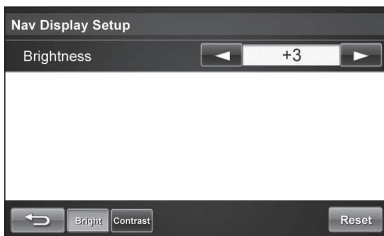

## Camera Display Setup

*Brightness / Color / Tint / Contrast / Sharpness*





### 4 Touch [ ] or [ ] for the selected item to change its setting.

- When there are no more selections to view, the arrow is gray.

### 5 Touch [ ] to exit display setup menu.

## Adjusting Picture Brightness



*Min (-15) to Max (+15) (Default Setting: 0)*

Touch [  ] or [  ] to make the picture darker or lighter. When it reaches the minimum or maximum points, the display shows "Min" or "Max," respectively.

## Adjusting Picture Color

*Min (-15) to Max (+15) (Default Setting: 0)*



The color adjustment can be made only in AUX and Camera modes.

Touch [  ] or [  ] to make the color of the picture brighter or darker respectively to get your desired color. When it reaches the minimum or maximum color selections, the display shows "Min" or "Max," respectively.

## Adjusting Picture Tint

*G Max (15) to R Max (15) (Default Setting: ±0)*

The tint adjustment can be made only in AUX or Camera modes.

Touch [  ] or [  ] to adjust the tint (red or green) of the picture. When it reaches the maximum or minimum tint selections, the display shows "G Max" or "R Max," respectively.



## Adjusting Picture Contrast

### **Low (-15) to High (+15) (Default Setting: 0)**

Touch [◀] or [▶] adjust object contrast on the screen. When it reaches the minimum or maximum contrast level, the display shows "Low" or "High," respectively.

## Adjusting Picture Sharpness

### **Soft (-15) to Hard (+15) (Default Setting: 0)**

Touch [◀] or [▶] adjust the sharpness or clarity of the edge of an object appearing on the screen. When it reaches the minimum or maximum sharpness level, the display shows "Soft" or "Hard," respectively.

## Visual EQ Mode

### **Off (Default Setting) / Night Movie / Soft / Sharp / High Contrast**

- Off: The default setting.
- Night Movie: Suitable for movies containing dark scenes.
- Soft: Suitable for CGs and animated films.
- Sharp: Suitable for old movies where images are not clearly shown.
- High Contrast: Suitable for recent movies.

- *When any picture setting is changed, the Visual EQ item name is changed to "Custom."*

## **Reset Display Setting**

Reset only affects the individual display setup sources. Any picture setting can be reset without affecting the other settings.

When pressing the Reset button, the message, "Reset display values to default?" appears. Press "Reset" to go back to the factory setting.

# Information

## **In Case of Difficulty**

If you encounter a problem, please turn the unit power off, then on again, or turn the vehicle ACC off, then on again.

If the unit is still not functioning normally, please review the items in the following checklist. This guide will help you isolate the problem if the unit is at fault. Otherwise, make sure the rest of your system is properly connected, or then consult your authorized Alpine dealer.

## **Basic**

### **No function or display.**

- Vehicle's ignition is off.  
*If connected according to the instructions, the unit will not operate with the vehicle's ignition off.*
- Improper power lead connections.  
*Check power lead connections.*

### **No sound or unnatural sound.**

- Connections are not properly or securely made.  
*Check the connections and firmly connect.*

### **Screen not displayed.**

- Brightness control is set at the minimum position.  
*Adjust the Brightness control.*
- Temperature in the vehicle is too low.  
*Increase the vehicle's interior temperature to operation temperature range.*
- Connections to the DVD, navigation system are not securely made.  
*Check the connections and firmly connect.*

### **Navigation system inoperative.**

- Connections to the navigation system are incorrect.  
*Check the connections with the navigation system and connect the cables correctly and firmly.*

### No picture is produced.

- Monitor's mode is not switched to the mode you want to see.  
*Switch to the mode you want to see.  
Make sure your input device is connected.*

### Picture is unclear or noisy.

- Vehicle's battery power is weak.  
*Check the battery power and wiring.  
(The unit may malfunction if the battery power is under 11 volts with a load applied.)*

### Spots or dotted lines/stripes appear.

- Caused by neon signs, high-voltage power lines, Walkie-Talkie or cell phone, other vehicle's ignition plugs, etc.  
*Change the location of your vehicle.*

### Caution Display



### Picture Off For Your Safety Message Appears.

- Whenever the hand brake is off, the AUX screen turns to black and the message appears. Park the vehicle and set the hand brake.  
*See page 21, "Lock-out Function".*



### Can't Operate While Driving Message Appears.

- Whenever the hand brake is off, the setup menu turns to black and this message appears.  
*Park the vehicle and set the hand brake.  
See page 21, "Lock-out Function".*

## Specifications

### MONITOR SECTION

Screen Size	6.5 inch
Resolution	WVGA
Operation System	TFT active matrix
Number of Picture Elements	1,152,000 pcs.
Effective Number of Picture Elements	99.99% or more

Illumination System LED

### GENERAL

Power Requirement	14.4 V DC (11–16 V allowable)
Operation Temperature	-10°C (+14°F) to +60°C (+140°F)
Storage Temperature	-20°C (-4°F) to +75°C (+167°F)

### CHASSIS SIZE (Monitor section)

Width	178 mm (7")
Height	100 mm (3-15/16")
Depth	36 mm (1-7/16")
Weight (Monitor Section)	385 g (12.44 oz)

### HIDEAWAY BOX

Width	88 mm (3-7/16")
Height	60 mm (2-3/8")
Depth	28 mm (1-1/8")

- *Due to continuous product improvement, specifications and design are subject to change without notice.*
- *The LCD panel is manufactured using an extremely high-precision manufacturing technology. Its effective pixel ratio is over 99.99% meaning that it is possible that 0.01% of the pixels could be either always ON or OFF.*

## Accessories

### Check accessory parts

Touch-Display Monitor      Hideaway Box with Cable



x 1

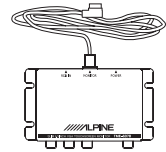

x 1

Power Connector

Parking Wire

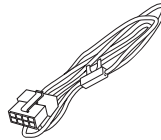

x 1



x 1

---

---

# Installation and Connections

Before installing or connecting the unit, please read the following and pages 2 to 3 of this manual thoroughly for proper use.



## WARNING

---

### MAKE THE CORRECT CONNECTIONS

Failure to make the proper connections may result in fire or product damage.

---

### USE ONLY IN CARS WITH A 12 VOLT NEGATIVE GROUND.

(Check with your dealer if you are not sure.) Failure to do so may result in fire, etc.

---

### BEFORE WIRING, DISCONNECT THE CABLE FROM THE NEGATIVE BATTERY TERMINAL.

Failure to do so may result in electric shock or injury due to electrical shorts.

---

### DO NOT ALLOW CABLES TO BECOME ENTANGLED IN SURROUNDING OBJECTS.

Arrange wiring and cables in compliance with the manual to prevent obstructions when driving. Cables or wiring that obstruct or hang up on places such as the steering wheel, shift lever, brake pedals, etc. can be extremely hazardous.

---

### DO NOT SPLICE INTO ELECTRICAL CABLES.

Never cut away cable insulation to supply power to other equipment. Doing so will exceed the current carrying capacity of the wire and result in fire or electric shock.

---

### DO NOT DAMAGE PIPE OR WIRING WHEN DRILLING HOLES.

When drilling holes in the chassis for installation, take precautions so as not to contact, damage or obstruct pipes, fuel lines, tanks or electrical wiring. Failure to take such precautions may result in fire.

---

### DO NOT USE BOLTS OR NUTS IN THE BRAKE OR STEERING SYSTEMS TO MAKE GROUND CONNECTIONS.

Bolts or nuts used for the brake or steering systems (or any other safety-related system), or tanks should NEVER be used for installations or ground connections. Using such parts could disable control of the vehicle and cause fire etc.

---

### KEEP SMALL OBJECTS SUCH AS BOLTS OR SCREWS OUT OF THE REACH OF CHILDREN.

Swallowing them may result in serious injury. If swallowed, consult a physician immediately.

---

### DO NOT INSTALL IN LOCATIONS WHICH MIGHT HINDER VEHICLE OPERATION, SUCH AS THE STEERING WHEEL OR GEARSHIFT.

Doing so may obstruct forward vision or hamper movement etc. and results in serious accident.



## CAUTION

---

### HAVE THE WIRING AND INSTALLATION DONE BY EXPERTS.

The wiring and installation of this unit requires special technical skill and experience. To ensure safety, always contact the dealer where you purchased this product to have the work done.

---

### USE SPECIFIED ACCESSORY PARTS AND INSTALL THEM SECURELY.

Be sure to use only the specified accessory parts. Use of other than designated parts may damage this unit internally or may not securely install the unit in place. This may cause parts to become loose resulting in hazards or product failure.

---

### ARRANGE THE WIRING SO IT IS NOT CRIMPED OR PINCHED BY A SHARP METAL EDGE.

Route the cables and wiring away from moving parts (like the seat rails) or sharp or pointed edges. This will prevent crimping and damage to the wiring. If wiring passes through a hole in metal, use a rubber grommet to prevent the wire's insulation from being cut by the metal edge of the hole.

---

### DO NOT INSTALL IN LOCATIONS WITH HIGH MOISTURE OR DUST.

Avoid installing the unit in locations with high incidence of moisture or dust. Moisture or dust that penetrates into this unit may result in product failure.



## PRECAUTIONS

- Be sure to disconnect the cable from the (-) battery post before installing your TME-S370. This will reduce any chance of damage to the unit in case of a short-circuit.
- Be sure to connect the color coded leads according to the diagram. Incorrect connections may cause the unit to malfunction or damage to the vehicle's electrical system.
- When making connections to the vehicle's electrical system, be aware of the factory installed components (e.g. on-board computer). Do not tap into these leads to provide power for this unit. When connecting the TME-S370 to the fuse box, make sure the fuse for the intended circuit of the TME-S370 has the appropriate amperage. Failure to do so may result in damage to the unit and/or the vehicle. When in doubt, consult your ALPINE dealer.
- The TME-S370 uses female RCA-type jacks for connection to other units having RCA connectors. You may need an adaptor to connect other units. If so, please contact your authorized ALPINE dealer for assistance.
- The Display must be completely retracted in the casing when installing. If it is not, problems may occur.

## Mounting Options

### Mounting the Monitor on the Dashboard Using a Bracket

The bracket is not included. Ask your dealer to make a custom bracket that is suitable for your vehicle.

- 1 Mount the bracket using the screws (M5 x 8).**
- 2 Mount the bracket on back side of the monitor.**

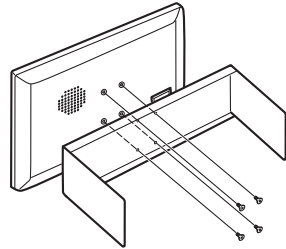

- 3 Mount the monitor with bracket attached in the car.**

### Attaching the Monitor and Stand



#### **CAUTION**

**Do not install the monitor near the front passenger seat air bag system.**

You can purchase an aftermarket monitor stand. Mount the monitor by following the installation manual for the monitor stand.

### Mounting Monitor at Headrest

Ask your dealer to install the headrest cup kit or headrest pole bracket.

# Connections

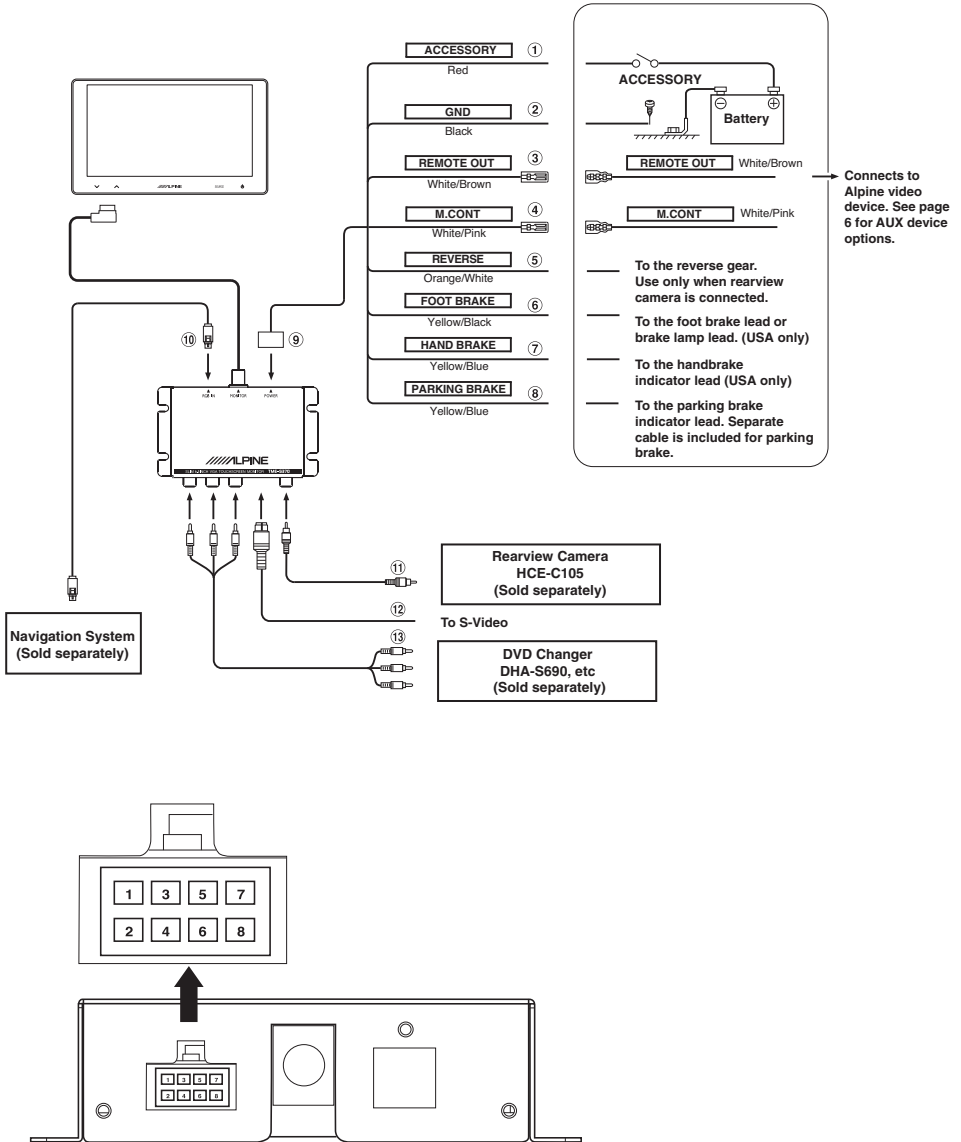

- |   |                              |              |  |
|---|------------------------------|--------------|--|
| ① | <b>ACC (+12V)</b>            | Red          | Connect to vehicle accessory / ignition  |
| ② | <b>GND</b>                   | Black        | Connect to vehicle ground line   |
| ③ | <b>REMOTE</b>                | White/Brown  | Remote out for controlling peripherals   |
| ④ | <b>M-CONT</b>                | White/Pink   | "Monitor Control" activate while S3 remote function is used  |
| ⑤ | <b>REVERSE</b>               | Orange/White | Switch to rearview camera screen   |
| ⑥ | <b>FOOT BRAKE</b>            | Yellow/Black | Enables displaying video or operating setup (For front use)  |
| ⑦ | <b>HAND BRAKE</b>            | Yellow/Blue  | Enables displaying video or operating setup (For front use)  |
| ⑧ | <b>PARKING BRAKE</b>         | Yellow/Blue  | Enables displaying video or operating setup (For rear use)<br>For USA, parking brake wire pin is for rear seat entertainment use. It is not connected at factory for US model. The wire pin is included in a bag with a caution note.<br>For other regions, parking brake wire pin is connected at factory. Foot and hand brake wires are not necessary. |
| ⑨ | <b>POWER CONNECTOR</b>       |              |  |
| ⑩ | <b>RGB CABLE</b>             |              |  |
| ⑪ | <b>CAMERA INPUT TERMINAL</b> |              |  |
| ⑫ | <b>S-VIDEO CABLE</b>         |              |  |
| ⑬ | <b>RCA EXTENSION CABLE</b>   |              |  |

### Lock-out Function

To watch AUX device or operate setup functions, the Lock-out needs to be disabled. To do this, follow the procedure below.

- 1 Bring your vehicle to a complete stop at a safe location. Engage the hand brake.**
- 2 Keep pushing the foot brake and release the hand brake once then engage it again.**
- 3 When the hand brake is engaged for the second time, release the foot brake.**

Now, the locking system for the AUX mode operation has been released. Engaging the hand brake can reactivate the AUX mode, as long as the car's ignition has not been turned off. It is not necessary to repeat the above procedure (1 through 3), of "Lock-out Function".

- *If you try to activate the auxiliary device while driving, the display will show the warning-Picture Off For Your Safety.*